

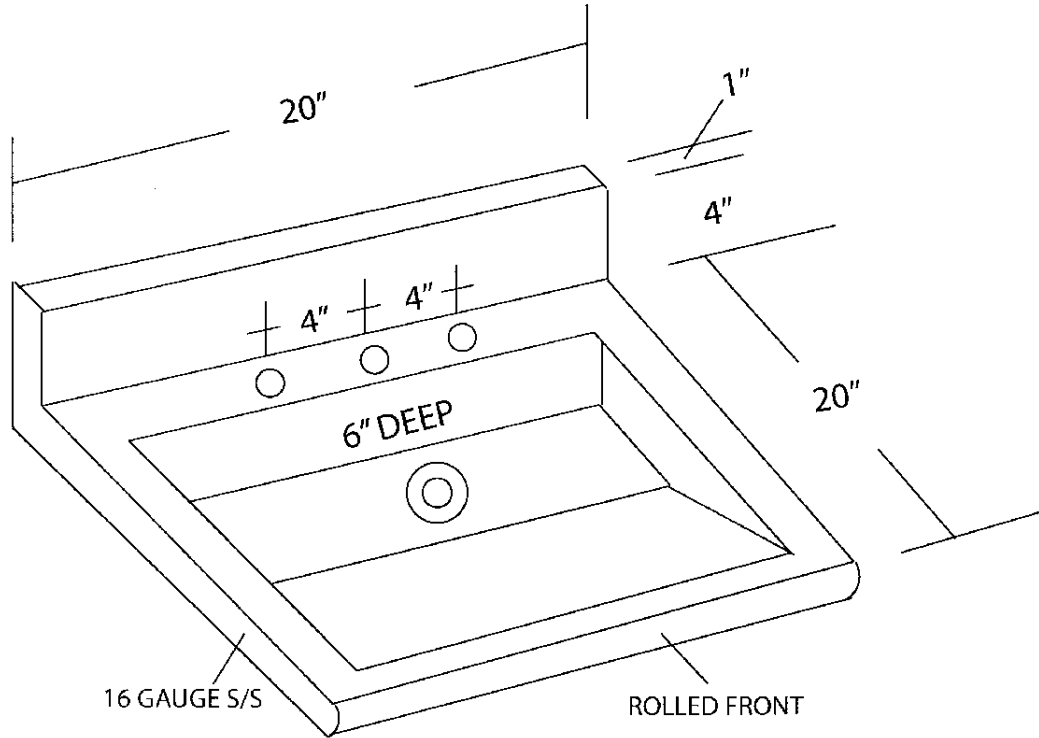

LAMBERTSON INDUSTRIES

HIGH-QUALITY STAINLESS STEEL
HAND SINK SCHEMATICS

LI-ADA-2021-8



MODEL	LENGTH	WIDTH	BACK SPLASH	WEIGHT
LI-ADA-2021-8	20"	21"	4"	64 LBS.
OTHER SPECIFICATIONS				
BOWL SIZE — 18" X 14-1/2" X 6"		OVERALL DIMENSIONS. — 30" X 21" X 10"		

LAMBERTSON STAINLESS STEEL PRODUCTS ARE  APPROVED AND MEET STANDARD #2-DO21814

LAMBERTSON INDUSTRIES • 1335 ALEXANDRIA COURT • SPARKS, NV 89434

PHONE: 775-857-1100 • FAX: 775-857-3289 • TOLL-FREE: 800-548-3324

